

Stereophonic

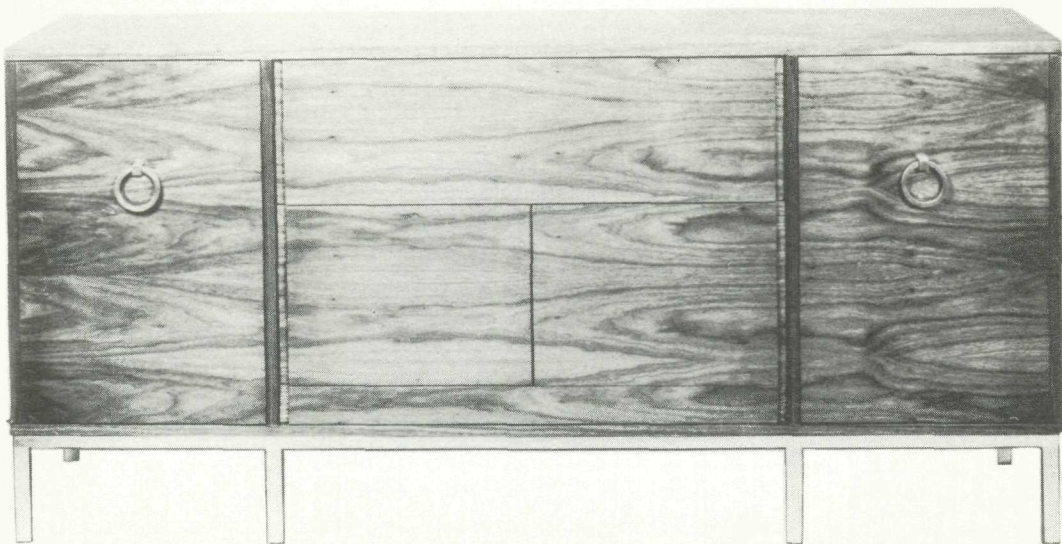

**THE FISHER
PRESIDENT III & IV
SERVICE
MANUAL**



PRESIDENT III AND IV

PRICE: \$1.00

FISHER RADIO CORPORATION • NEW YORK

THE FISHER PRESIDENT III & IV



VOLTAGE MEASUREMENTS

FM-AM TUNER-4000R

All readings taken with vacuum-tube voltmeter with respect to chassis ground, subject to 10% normal variation unless otherwise noted. Set dial pointer at extreme low end of scale. AM Selector at SHARP, FM Selector at LISTEN. Set line voltage at 117 volts AC, 50-60 cycles. Readings are in DC volts with respect to chassis ground, unless otherwise noted. Use vacuum-tube voltmeter.

TUBE SOCKET PIN NUMBER									
SYMBOL TUBE	1	2	3	4	5	6	7	8	9
V1 - ECC88/6DJ8	190	95	96	0	6.3AC	98	-0.3	1.5	0
V2 - ECC85/6AQ8	175	-2.1	0	6.3AC	0	170	-2.7	0	0
V3 - 6AU6	-0.3	0	6.3AC	0	205	77	0.5	-	-
V4 - 6AU6	0	0	6.3AC	0	205	70	0.6	-	-
V5 - 6AU6	0.5	0	6.3AC	0	205	76	0	-	-
V6 - 6AU6	6	0	6.3AC	0	205	90	0	-	-
V7 - 6BJ6	-0.1	0.9	6.3AC	0	203	80	0	-	-
V8 - 6BE6	-7.5	0	6.3AC	0	207	90	-0.4	-	-
V9 - 6BJ6	-0.4	0.6	6.3AC	0	205	68	0	-	-
V10 - EBF89	95	0	2.1	6.3AC	0	200	1.9	-0.1	0
V11 - EM84/6FG6	0.6	NC	2.1	0	6.3AC	209	38	NC	38
V12 - EM840	0.6	NC	0	0	6.3AC	209	46	NC	46
V13 - EF86/6267	240AC	NC	290	0	6.3AC	NC	240AC	NC	NC
V14 - EZ81/6CA4	105	1.5	1.5	6.3AC	0	78	1.5	1.5	0
V15 - EF86/6267	90	1.5	1.5	6.3AC	0	90	1.5	1.5	0

ELECTROLYTIC CAPACITOR	TERMINAL SYMBOL	VOLTAGE	NOTES AC=AC volts NC=No Connection
C25	◐	280	
C25	◑	255	
C36	◐	230	
C36	◑	210	
C36	◑	190	

TUBE LAYOUT

FM-AM TUNER-4000R

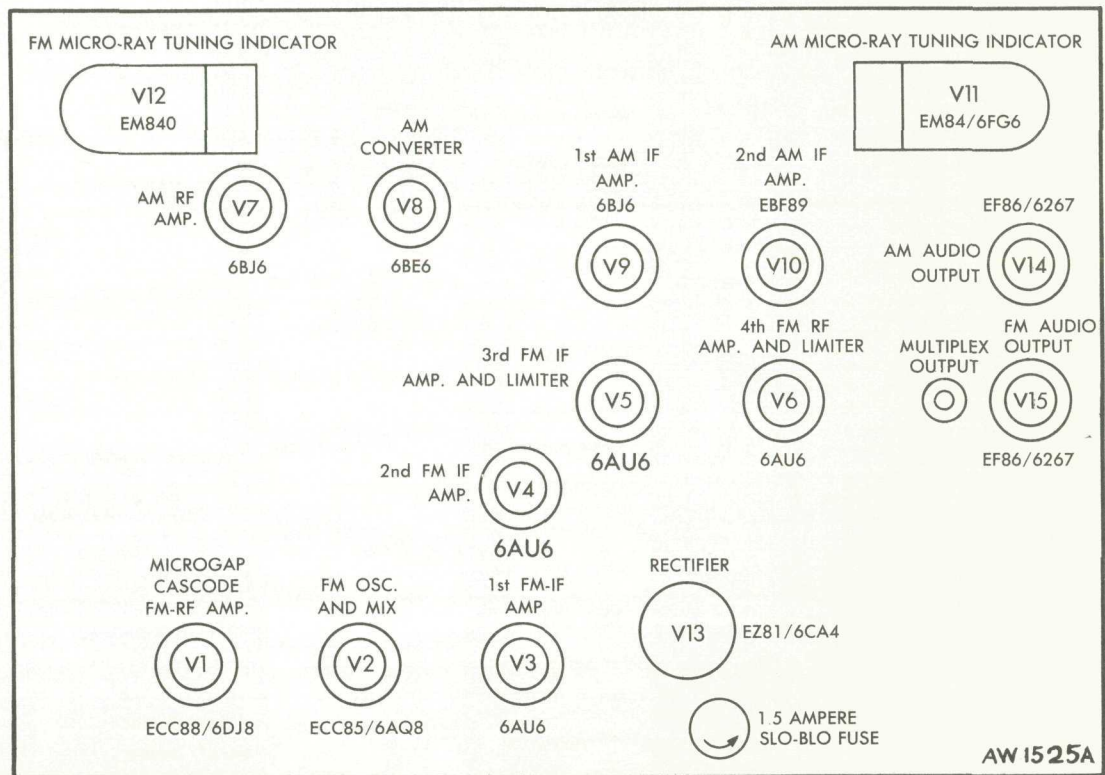

ALIGNMENT INSTRUCTIONS

Read These Instructions With Extreme Care Before Attempting Alignment.

CHASSIS: Turn the station selectors completely counterclockwise, without forcing. Dial pointers should be at zero index mark on logging scale. If not, reset the dial pointers. Disconnect the external antennas and the antenna link. When using an oscilloscope for alignment, set the output level controls for no overload, as shown by the proper waveform shape.

SIGNAL GENERATORS: The signal generator equipment must be able to supply the following: AM RF modulated 30% at 400 cps, FM RF modulated 30% (± 22.5 KC deviation) at 400 cps, accurately

calibrated 10 KC audio output for adjusting the 10 KC AM whistle filter, AM IF with 30 KC sweep for AM bandwidth adjustment.

INDICATOR: DC VTVM and scope for alignment. AC VTVM for 10 KC AM whistle filter adjustment.

ALIGNMENT: Allow the chassis and test instruments to warm up for at least fifteen minutes. Adjust the line voltage for 117 volts AC, 50-60 cycles. Use fully insulated tools: a small screwdriver for all capacitors and L17; a K-Tran tool for Z1, Z2, Z3, Z6, Z7, Z8 and Z9; a hex tool for Z4, Z5, L2, L8 and L9.

AM ALIGNMENT

STEPS	CHASSIS			SIGNAL GENERATOR			INDICATOR		ALIGNMENT	
	AM SELECTOR	FM SELECTOR	STATION SELECTOR	COUPLING	FREQ.	MOD.	TYPE	CONNECTION	ADJUST	INDICATION
1	BROAD	FM OFF	Point of no signal and no interference	Audio Gen. connected to Pin 7 of V10	10 KC	None	AC VTVM to AM Stereo Output		C52	Minimum output
2	SHARP	FM OFF	Point of no signal and no interference	.01-uf cap. in series with hot lead to V8, Pin 7	455 KC	30% AM at 400 cps	DC VTVM to Pin 1 of V11		Z7, Z8, Z9 top and bottom	Maximum negative voltage
3	BROAD	FM OFF	Point of no signal and no interference	.01-uf cap. in series with hot lead to V8, Pin 7	455 KC	30 KC sweep	Scope to AM Stereo Output		Z9 top	Adjust slightly for symmetrical curve
4	SHARP	FM OFF	600 KC	220-uuf cap. in series with hot lead to antenna terminal 3	600 KC	30% AM at 400 cps	DC VTVM to Pin 1 of V11		L17, Z6	Maximum negative voltage
5	SHARP	FM OFF	1400 KC	220-uuf cap. in series with hot lead to antenna terminal 3	1400 KC	30% AM at 400 cps	DC VTVM to Pin 1 of V11		C6F, C6D, C6B	Maximum negative voltage
6	Repeat steps 4 and 5 at least once for proper dial calibration and maximum output.									
7	AM OFF	LISTEN	Point of no signal and no interference	Ungrounded tube shield of V2	10.7 MC	None	DC VTVM to the junction of R67 and C82		Z1, Z2, Z3 top & bottom & Z4 bottom	Maximum negative voltage
8	AM OFF	LISTEN	Point of no signal and no interference	Ungrounded tube shield of V2	10.7 MC	None	DC VTVM to C93 negative terminal		Z5 bottom	Maximum negative voltage
9	AM OFF	LISTEN	Point of no signal and no interference	Ungrounded tube shield of V2	10.7 MC	None	Connect two matched 47K resistors across C93. Connect DC VTVM to the junction of the two 47K Res. Ground side of VTVM to the junction of R75 and C87.		Z5 top	Zero reading on zero center scale
10	AM OFF	LISTEN	106 MC	Two 120-ohm carbon resistors in series with lead to antenna terminals 4 and 5	106 MC	30% FM (22.5 KC Dev.) at 400 cps	DC VTVM to the junction of R67 and C82 and scope to FM Stereo Output		C32	Check for sine waveform and adjust for maximum negative voltage
11	AM OFF	LISTEN	90 MC	Two 120-ohm carbon resistors in series with lead to antenna terminals 4 and 5	90 MC	30% FM (22.5 KC Dev.) at 400 cps	DC VTVM to the junction of R67 and C82 and scope to FM Stereo Output		L9	Check for sine waveform and adjust for maximum negative voltage
12	AM OFF	LISTEN	106 MC	Two 120-ohm carbon resistors in series with lead to antenna terminals 4 and 5	106 MC	30% FM (22.5 KC Dev.) at 400 cps	DC VTVM to the junction of R67 and C82 and scope to FM Stereo Output		C3 and C20	Check for sine waveform and adjust for maximum negative voltage
13	AM OFF	LISTEN	90 MC	Two 120-ohm carbon resistors in series with lead to antenna terminals 4 and 5	90 MC	30% FM (22.5 KC Dev.) at 400 cps	DC VTVM to the junction of R67 and C82 and scope to FM Stereo Output		L2 & L8	Check for sine waveform and adjust for maximum negative voltage
14	Repeat steps 10 through 13 at least once for proper dial calibration and maximum output.									
NOTE: For calibrating both the RF and IF, use as low an output voltage as possible from your signal generator.										

FM ALIGNMENT

CAPACITORS

20% tolerance for a.f. fixed capacitors, unless otherwise noted or marked GMV (guaranteed minimum value.)

Symbol	Description	Part No.
C1	Ceramic, 24uuf 5% N150, 1000V	C50070-8
C2	Ceramic, 8uuf \pm .5uuf NPO, 500V	CC20CJ080D5
C3	Ceramic Trimmer	C662-123
C4	Ceramic, 10uuf NPO, 500V	CC20CH100G5
C5	Ceramic, 100uuf 10% N1500, 1000V	C50070-6
C6	Variable, AM	C684-127
C7	Variable, FM	C662-113
C8	Ceramic, 100uuf GMV N1500, 1000V	C50070-5
C9	Ceramic, 100uuf 10% N1500, 1000V	C50070-6
C10, 11,	Ceramic, Feedthru, 1000uuf GMV	C592-187
12		
C13	Ceramic, .02uf +80—20%, 500V	C50089-4
C14	Molded, .01uf, 600V	C2747
C15	Ceramic, Feedthru, 1000uuf GMV	C592-187
C16	Ceramic, .02uf +80—20%, 500V	C50089-4
C17	Ceramic, .005uf, 500V	C50089-1
C18	Ceramic, Feedthru, 100uuf GMV	C592-187
C19	Ceramic, .005uf, 500V	C50089-1
C20	Ceramic Trimmer	C662-123
C21	Ceramic, .68uf, 500V	C50077-6N
C22	Ceramic, 5uuf \pm .5uuf NPO, 500V	CC20CJ050D5
C23	Ceramic, 100uuf 10% N1500, 100V	C50070-6
C24	Ceramic, 10uuf NPO, 500V	CC20CH100G5
C25	Electrolytic, two sections: 40uf, 350V 40uf, 300V	C684-122
C26	Ceramic, Feedthru, 100uuf GMV	C592-187
C27	Ceramic, 68uuf 10% N750, 500V	CC20UJ680K5
C28	Ceramic, 100uuf 10% N1500, 1000V	C50070-6
C29	Ceramic, 100uuf, \pm .5uuf N220, 500V	CC20RH100D5
C30	Ceramic, 47uuf 10% N750, 1000V	C50070-4
C31	Ceramic, Feedthru, 1.00uuf GMV	C592-187
C32	Ceramic Trimmer	C662-123
C33	Ceramic, 24uuf 5% N150, 1000V	C50070-8
C34	Ceramic, 100uuf 10% N1500, 1000V	C50070-6
C35	Ceramic, 100uuf GMV N1500, 1000V	C50070-5
C36	Electrolytic, three section: 40uf, 300V 40uf, 300V 20uf, 250V	C684-119
C37	Ceramic, .005uf, 500V	C50089-1
C38	Ceramic, 1000uuf 10%, 1000V	C50072-3
C39	Ceramic, 8uuf \pm .25uuf	CC20VK080C5
C40	Ceramic, .02uf +80—20%, 500V	C50089-4
C41	Ceramic, .005uf, 500V	C50089-1
C42	Ceramic, Feedthru, 1000uuf GMV	C592-187
C43	Ceramic, .02uf +80—20%, 500V	C50089-4
C44	Mica, 470uuf 5%, 300V	C3334
C45, 46	Ceramic, .005uf, 500V	C50089-1
C47	Ceramic, .0027uf, 1000V	C50071-5
C48	Mica, 470uuf 5%, 300V	C3334
C49	Ceramic, .005uf, 500V	C50089-1
C50, 51	Molded, .047uf 10%, 250V	C50074-27
C52	Mica, Trimmer, 160uuf-500uuf	C629-151-5
C53	Ceramic, 47uuf 10% N750, 1000V	C50070-4
C54	Ceramic, 560uuf, 10%, 1000V	C50072-14
C55	Ceramic, .02uf +80—20%, 500V	C50089-4
C56	Ceramic, .005uf, 500V	C50089-1
C57	Mica, 470uuf 5%, 300V	C3334
C58	Ceramic, .005uf, 500V	C50089-1
C59	Molded, .1uf 10%, 250V	C50074-28
C60	Molded, .1uf 10%, 250V	C50074-28
C61	Electrolytic, 25uf, 6V	C639-114
C62	Ceramic, .0027uf, 1000V	C50071-5
C63	Mica, 470uuf 5%, 300V	C3334
C64	Ceramic, .005uf, 500V	C50089-1
C65	Ceramic, 10uuf NPO, 500V	CC20CH100G5
C66	Ceramic, .02uf +80—20%, 500V	C50089-4

C67	Ceramic, 47uuf 10% N750, 1000V	C50070-4
C68, 69	Ceramic, .005uf, 500V	C50089-1
C70	Ceramic, .0027uf, 1000V	C50071-5
C71	Ceramic, .005uf, 500V	C50089-1
C72	Ceramic, 1uuf P100, 1000V	C50070-1
C73	Ceramic, 220uuf 10%, 500V	CC21GP221K5
C74	Molded, .1uf 10%, 250V	C50074-28
C75	Molded, .047uf 10%, 250V	C50074-27
C76	Electrolytic, 25uf, 6V	C639-114
C77	Ceramic, .005uf, 500V	C50089-1
C78	Ceramic, .0027uf, 1000V	C50071-5
C79	Ceramic, 100uuf GMV N1500, 1000V	C50070-5
C80	Ceramic, .005uf, 500V	C50089-1
C81	Ceramic, 330uuf, 10%, 1000V	C50072-1
C82	Molded, .047uf 10%, 250V	C50074-27
C83	Ceramic, .02uf +80—20%, 500V	C50089-4
C84	Ceramic, .005uf, 500V	C50089-1
C85	Ceramic, 330uf 10%, 1000V	C50072-1
C86	Ceramic, 24uuf 5% N150, 1000V	C50070-8
C87	Ceramic, .0022uf 10%, 1000V	C50072-5
C88	Ceramic, .02uf +80—20%, 500V	C50089-4
C89	Molded, .01uf 10%, 250V	C50074-25
C90	Molded, .047uf 10%, 250V	C50074-27
C91, 92	Ceramic, 330uuf 10%, 1000V	C50072-1
C93	Electrolytic, 8uf, 50V	C629-138
C94	Ceramic, 100uuf GMV N1500, 100V	C50070-5

RESISTORS AND POTENTIOMETERS

In ohms, 10% tolerance, 1/2 watt, unless otherwise noted. K = kilohm, M = megohm.

Symbol	Description	Part No.
R1	Composition, 1K	RC20BF102K
R2	Composition, 270	RC20BF271K
R3	Composition, 4.7	RC20BF47K
R4	Composition, 100K	RC20BF104K
R5	Composition, 1.8M	RC20BF185K
R6	Composition, 1.2K	RC20BF122K
R7	Composition, 4.7M	RC20BF475K
R8	Composition, 100	RC20BF101K
R9	Composition, 330K	RC20BF334K
R10	Composition, 47K	RC20BF473K
R11	Composition, 330K	RC20BF334K
R12	Composition, 1K	RC20BF102K
R13	Composition, 4.7	RC20BF47K
R14	Composition, 2.2K	RC20BF222K
R15	Composition, 22	RC20BF220K
R16	Wirewound, 75, 5W	R684-140
R17	Composition, 820K	RC20BF824K
R18, 19	Wirewound, 270, 5W	R684-141
R20	Composition, 470K	RC20BF474K
R21	Composition, 22K	RC20BF223K
R22	Composition, 100	RC20BF101K
R23	Wirewound, 270, 5W	R684-141
R24	Composition, 1K	RC20BF102K
R25	Composition, 2.2K, 1W	RC30BF223K
R26	Composition, 2.2K, 1W	RC30BF222K
R27	Composition, 1K	RC20BF102K
R28	Composition, 100	RC20BF101K
R29	Composition, 1K	RC20BF102K
R30	Composition, 82K	RC20BF823K
R31	Composition, 47K	RC20BF473K
R32	Potentiometer, 500K 20%	R520-139
R33	Composition, 1K	RC20BF102K
R34	Composition, 100	RC20BF101K
R35	Composition, 330K	RC20BF334K
R36	Composition, 5.6K	RC20BF562K
R37	Composition, 2.2M	RC20BF225K
R38	Composition, 1M	RC20BF105K
R39	Composition, 82K	RC20BF823K
R40	Composition, 1K	RC20BF102K
R41	Composition, 47K	RC20BF473K
R42	Composition, 560	RC20BF561K

R43	Composition, 120	RC20BF121K
R44	Composition, 150K	RC20BF154K
R45	Composition, 82K	RC20BF823K
R46	Composition, 1K	RC20BF102K
R47	Composition, 2.2M	RC20BF225K
R48	Composition, 1.8M	RC20BF185K
R49	Composition, 820K	RC20BF824K
R50	Composition, 1.8M	RC20BF185K
R51	Composition, 180	RC20BF181K
R52	Composition, 120K	RC20BF124K
R53	Composition, 47K	RC20BF473K
R54	Composition, 82K	RC20BF823K
R55, 56	Composition, 1K	RC20BF102K
R57	Composition, 3.3M	RC20BF335K
R58	Composition, 56K	RC20BF563K
R59	Composition, 22K	RC20BF223K
R60, 61	Composition, 330K	RC20BF334K
R62	Composition, 470K	RC20BF474K
R63	Composition, 22K	RC20BF223K
R64	Composition, 10M	RC20BF106K
R65	Composition, 39K	RC20BF393K
R66	Composition, 560	RC20BF561K
R67	Composition, 2.2M	RC20BF225K
R68	Composition, 330K	RC20BF334K
R69	Composition, 1.8M	RC20BF185K
R70	Composition, 1M	RC20BF105K
R71	Composition, 1K	RC20BF102K
R72	Composition, 470K	RC20BF474K
R73	Composition, 330K	RC20BF334K
R74	Composition, 270	RC20BF271K
R75	Composition, 33K	RC20BF333K
R76	Composition, 1K	RC20BF102K
R77	Composition, 22K	RC20BF223K
R78	Potentiometer, 500K 20%	R520-139
R79	Composition, 15K	RC20BF153K
R80	Composition, 1.5K	RC20BF152K

COILS, TRANSFORMERS, CHOKES

Symbol	Description	Order No.
L1	Choke, RF 3.3 Micro Henries	L50066-8
L2	Coil, Tuned, FM Antenna	L662-124
L3	Coil, AM Antenna	L721-139
L4	Choke, RF 1.2 Micro Henries	L50066-3
L5, 6	Choke, RF .56 Micro Henries	L50066-19
L7	Choke, RF	L629-180
L8	Coil, Tuned, FM-RF	L662-125
L9	Coil, Tuned, FM Oscillator	L662-126
L10, 11	Choke, RF 1.2 Micro Henries	L50066-3
L12, 13	Choke, Ferrite Bead, Filament	L592-189
L14	Choke, RF 1.2 Micro Henries	L50066-3
L15	Choke, RF .56 Micro Henries	L50066-19
L16	Choke, RF 1.2 Micro Henries	L50066-3
L17	Coil, AM Oscillator	L550-122
L18, 19	Choke, Ferrite Bead, Filament	L592-189
L20	Coil, 10kc Filter	L644-120
L21	Loop, AM	L721-136
T1	Transformer, Power	T684-124
Z1	Transformer, FM-IF	ZZ662-117
Z2, 3	Transformer, FM-IF	ZZ629-142
Z4	Coil, FM Limiter	L670-145
Z5	Transformer, FM Detector	ZZ592-170
Z6	Transformer, AM-RF	L670-151
Z7, 8	Transformer, AM-IF	ZZ509-132
Z9	Transformer, AM-IF	ZZ2984

MISCELLANEOUS

CR1, 2	Crystal Diode, Matched Pair, FM Detector	V-1N542
F1	Fuse, 1 1/2 Ampere, Slo-Blo	F684-143
I1, 2	Lamp, Dial Edge Lighting	I50082
S1	Switch, AM Selector	S684-123
S2	Switch, FM Selector	S684-120
S3	Switch, AC Power	Part of S1

SCHEMATIC DIAGRAM • MASTER AUDIO CONTROL-4000C

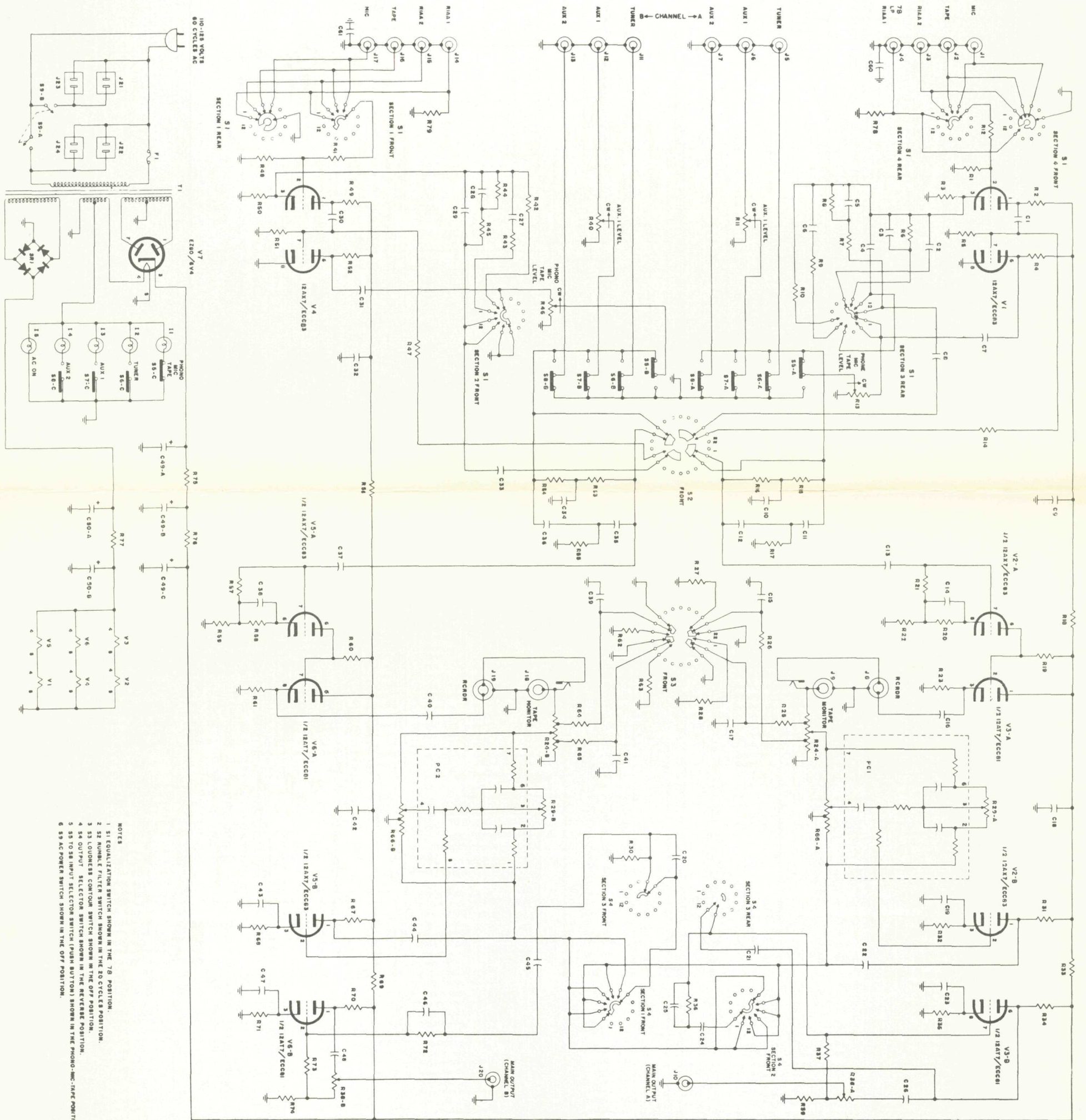

- NOTES
- 1 S1 EQUALIZATION SWITCH SHOWN IN THE 70 POSITION.
 - 2 S2 RUMBLE FILTER SWITCH SHOWN IN THE 20 CYCLES POSITION.
 - 3 S3 LOUDNESS CONTROL SWITCH SHOWN IN THE OFF POSITION.
 - 4 S4 OUTPUT SELECTOR SWITCH SHOWN IN THE REVERSE POSITION.
 - 5 S5 TO 50 INPUT SELECTOR SWITCH (PUSH BUTTON) SHOWN IN THE PHONO-MIC-TRF POSITION.
 - 6 S6 AC POWER SWITCH SHOWN IN THE OFF POSITION.

PARTS DESCRIPTION LIST • MASTER AUDIO CONTROL-4000C

CAPACITORS

20% tolerance for all capacitors, unless noted otherwise.

SYMBOL	ORDER NO.	DESCRIPTION
C1	C-50089-1	Two in parallel: Ceramic disc, .005 uf, 500V
C2	C-50072-20	Ceramic, 220 uuf, 10%, 1000V
C3	C-50072-7	Ceramic disc, 820 uuf, 10%, 1000V
C4	C-50072-6	Ceramic disc, 390 uuf, 10%, 1000V
C5	C-50072-8	Ceramic disc, 1800 uuf, 10%, 1000V
C6	C-50072-14	Ceramic disc, 560 uuf, 10%, 1000V
C7	C-50074-18	Molded, .022 uf, 10%, 125V
C8	C-50089-1	Ceramic disc, .005 uf, 500V
C9	C-657-126	Electrolytic, four section: C9: 10 uf, 200V C18: 30 uf, 300V C32: 10 uf, 200V C42: 30 uf, 300V
C10	C-50074-25	Molded, .01 uf, 10%, 250V
C11, 12	C-50089-1	Ceramic disc, .005 uf, 500V
C13, 14	C-50074-25	Molded, .01 uf, 10%, 250V
C15	C-50074-27	Molded, .047 uf, 10%, 250V
C16	C-50074-29	Molded, 0.47 uf, 250V
C17	C-50074-26	Molded, .022 uf, 10%, 250V
C18	Part of C9	Electrolytic section, 30 uf
C19	C-639-114	Electrolytic, 25 uf, 6V
C20	C-50072-4	Ceramic disc, 1200 uuf, 1000V
C21	C-50072-16	Ceramic disc, 270 uuf, 10%, 1000V
C22	C-50074-28	Molded, 0.1 uf, 10%, 250V
C23	C-639-114	Electrolytic, 25 uf, 6V
C24	C-50074-22	Molded, .027 uf, 10%, 250V
C25	CC20CJ150K5	Ceramic, 15 uuf NPO, 10%, 500V
C26	C-50074-29	Molded, 0.47 uf, 250V
C27	C-50072-14	Ceramic disc, 560 uuf, 10%, 1000V
C28	C-50072-8	Ceramic disc, 1800 uuf, 10%, 1000V
C29	C-50072-6	Ceramic disc, 390 uuf, 10%, 1000V
C30	C-50089-1	Two in parallel: Ceramic disc, .005 uf, 500V
C31	C-50074-26	Molded, .022 uf, 10%, 250V
C32	Part of C9	Electrolytic section, 10 uf
C33	C-50089-1	Ceramic disc, .005 uf, 500V
C34	C-50074-25	Molded, .01 uf, 10%, 250V
C35, 36	C-50089-1	Ceramic disc, .005 uf, 500V
C37, 38	C-50074-25	Molded, .01 uf, 10%, 250V
C39	C-50074-26	Molded, .022 uf, 10%, 250V
C40	C-50074-29	Molded, 0.47 uf, 250V
C41	C-50074-27	Molded, .047 uf, 10%, 250V
C42	Part of C9	Electrolytic section, 30 uf
C43	C-639-114	Electrolytic, 25 uf, 6V
C44	C-50074-28	Molded, 0.1 uf, 10%, 250V
C45	C-50074-22	Molded, .027 uf, 10%, 250V
C46	CC20CJ080D5	Ceramic, 8 uuf ±0.5 uuf NPO, 500V
C47	C-639-114	Electrolytic, 25 uf, 6V
C48	C-50074-29	Molded, 0.47 uf, 250V
C49	C-657-125	Electrolytic, three-section: C49-A: 30 uf, 400V C49-B: 30 uf, 350V C49-C: 30 uf, 350V
C50	C-546-116	Electrolytic, two-section: C50-A: 1000 uf, 30V C50-B: 1000 uf, 30V Note: Use C-546-116 to replace C-552-106 used on some units.
C51-59	—	Not used
C60, 61	C-50070-6	Ceramic, 100 uuf, N1500, 10%, 1000V

RESISTORS AND POTENTIOMETERS

In ohms, 10% tolerance, 1/2 watt, unless otherwise noted. K = Kilohm. M = Megohm.

SYMBOL	ORDER NO.	DESCRIPTION
R1	RC20BF104K	Composition, 100K
R2	RC30BF334K	Composition, 330K, 1W
R3	RC30BF272K	Composition, 2700, 1W
R4	RC20BF224K	Composition, 220K
R5	RC20BF106K	Composition, 10M
R6	RC20BF125K	Composition, 1.2M
R7	RC20BF274K	Composition, 270K
R8	RC20BF225K	Composition, 2.2M
R9	RC20BF124K	Composition, 120K
R10	RC20BF394K	Composition, 390K
R11	R-657-134	Potentiometer, 250K, level set
R12	RC20BF103K	Composition, 10K
R13	R-657-134	Potentiometer, 250K, level set
R14	RC20BF335K	Composition, 3.3M
R15, 16	RC20BF225K	Composition, 2.2M
R17	RC20BF105K	Composition, 1M
R18	RC20BF104K	Composition, 100K
R19	RC20BF224K	Composition, 220K
R20	RC20BF272K	Composition, 2700
R21	RC20BF225K	Composition, 2.2M
R22	RC20BF273K	Composition, 27K
R23	RC30BF563K	Composition, 56K, 1W
R24	R-730-118	Potentiometer, dual, volume: R24-A: 100K R24-B: 100K
R25	RC20BF103K	Composition, 10K
R26	RC20BF472K	Composition, 4700
R27	RC20BF822K	Composition, 8200
R28	RC20BF183K	Composition, 18K
R29	R-657-136	Potentiometer, dual, bass: R29-A: 1M R29-B: 1M
R30	RC20BF474K	Composition, 470K
R31	RC20BF104K	Composition, 100K
R32	RC20BF152K	Composition, 1500
R33	RC20BF103K	Composition, 10K
R34	RC30BF473K	Composition, 47K, 1W
R35	RC20BF331K	Composition, 330
R36	RC20BF474K	Composition, 470K
R37	RC20BF334K	Composition, 330K
R38	R-657-154	Potentiometer, dual, channel balance: R38-A: 25K R38-B: 25K
R39	RC20BF822K	Composition, 8200
R40	R-657-134	Potentiometer, 250K, level set
R41	RC20BF103K	Composition, 10K
R42	RC20BF394K	Composition, 390K
R43	RC20BF124K	Composition, 120K
R44	RC20BF225K	Composition, 2.2M
R45	RC20BF274K	Composition, 270K
R46	R-657-134	Potentiometer, 250K, level set
R47	RC20BF335K	Composition, 3.3M
R48	RC20BF104K	Composition, 100K
R49	RC30BF334K	Composition, 330K, 1W
R50	RC30BF272K	Composition, 2700, 1W
R51	RC20BF106K	Composition, 10M
R52	RC20BF224K	Composition, 220K
R53, 54	RC20BF225K	Composition, 2.2M
R55	RC20BF105K	Composition, 1M
R56	RC20BF104K	Composition, 100K
R57	RC20BF225K	Composition, 2.2M
R58	RC20BF272K	Composition, 2700
R59	RC20BF273K	Composition, 27K
R60	RC20BF224K	Composition, 220K
R61	RC30BF563K	Composition, 56K, 1W
R62	RC20BF183K	Composition, 18K
R63	RC20BF822K	Composition, 8200
R64	RC20BF103K	Composition, 10K
R65	RC20BF472K	Composition, 4700
R66	R-657-133	Potentiometer, dual, treble: R66-A: 500K R66-B: 500K
R67	RC20BF104K	Composition, 100K
R68	RC20BF152K	Composition, 1500
R69	RC20BF103K	Composition, 10K
R70	RC30BF473K	Composition, 47K, 1W
R71	RC20BF331K	Composition, 330
R72	RC20BF474K	Composition, 470K
R73	RC20BF334K	Composition, 330K
R74	RC20BF822K	Composition, 8200
R75, 76	RC30BF122K	Composition, 1200, 1W
R77	RC40BF100K	Composition, 10, 2W
R78, 79	RC20BF104K	Composition, 100K

MISCELLANEOUS

SYMBOL	ORDER NO.	DESCRIPTION
F1	F-3297	Fuse, 0.5 ampere
I1-5	A-50118	Lamp, channel indicator, AC pilot
J1-4	J-50081-2	Jack, dual
J5-7	J-50081-3	Jack, triple
J8, 10	J-50081-1	Jack, dual
J9	J-50088	Jack, shorting, monitor
J11-13	J-50081-3	Jack, triple
J14-17	J-50081-1	Jack, dual
J18	J-50088	Jack, shorting, monitor
J19, 20	J-5088-1	Jack, dual
J21-24	J-546-129	Receptacle, auxiliary AC
PC1, 2	PC-657-140	Printed ckt, tone control
S1	S-657-131	Switch, equalization selector
S2	S-657-132	Switch, rumble, filter
S3	S-657-138	Switch, loudness contour
S4	S-657-150	Switch, output selector
S5-8	S-657-129	Switch assembly, four pushbuttons, input channel selector
SR1	SR-50093	Selenium rectifier, filament supply
T1	T-657-115	Transformer, power
—	AS-50004-1	Shielded cable, 4 feet, with molded plugs
—	P-1031	Plug, standard RETMA

MECHANICAL PARTS

ORDER NO.	DESCRIPTION
I-50147-1	Jewel, red, AC pilot
I-50147-4	Jewel, green, channel indicator
A-50007	Retaining ring, jewel
E-50108-22	Knob, with gold triangle
E-546-108	Knob, pushbutton
E-546-135	Knob, lever
X-1036	Fuse holder, with cover
E-3287	Tube shield
AS-657-143	Bottom cover

MOUNTING HARDWARE

ORDER NO.	DESCRIPTION
1/2-inch shelf mounting:	
H1215383AA	Machine screw, 1-inch/8-32/RH, four required
A-657-147	Stand-off washer, 1/4-inch, four required
3/4-inch shelf mounting:	
H1215383AA	Machine screw, 1-inch/8-32/RH, four required
H101W106AA	Flat washer, four required
Leg mounting, without cabinet:	
H-657-145	Plastic leg, four required
H1215378AA	Machine screw, 1/2-inch/8-32/RH, four required

VOLTAGE AND RESISTANCE MEASUREMENTS

MASTER AUDIO CONTROL-4000C

All readings below taken with a vacuum-tube voltohmmeter with respect to chassis ground. All input selector pushbuttons out, and level set adjustments at minimum. Volume control at minimum. Bass, treble, and channel balance controls at mid-position. Loudness contour control off. Rumble filter at 20 cycles. Equalization selector at RIAA 1. Output selector at STANDARD.

Voltage Reference Chart

Set line voltage at 117 volts AC, 50-60 cycles. All readings are in DC volts with respect to chassis ground. Allow 15-minute instrument warm-up before taking measurements.

SYMBOL TUBES	TUBE SOCKET TERMINAL NUMBERS								
	1	2	3	4	5	6	7	8	9a
V1	85	0	P	12.6	0	90	N	0	6.3
V2	170	0	1.3	12.6	0	155	N	15	6.3
V3	265	155	155	25.2	12.5	125	0	1.3	18.9
V4	85	0	P	12.6	0	90	N	0	6.3
V5	170	0	1.3	25.2	12.6	155	6.3	15	18.9
V6	125	0	1.3	25.2	12.6	265	155	155	18.9
V7	300 AC	X	365	6.3 AC	0	X	300 AC	X	X
SUPPLY CAPACITORS	TERMINAL SYMBOLS	VOLTAGE		CHART NOTES AC Reading in AC volts N Less than 1 volt DC, negative P Less than 1 volt DC, positive X No connection a Dual-filament junction, V1-V6 c Sections of C9 (See parts list)					
C9	▲	185							
C18c	■	265							
C32c	—	185							
C42c	◐	265							
C49-A	◑	365							
C49-B	■	340							
C49-C	▲	320							
C50-A	▲	30							
C50-B	◑	25							

Resistance Reference Chart

Disconnect the chassis AC power cord. Discharge all electrolytic capacitors to chassis ground through a 100-ohm resistor. Disconnect all cables to associated equipment. Readings are in ohms with respect to chassis ground.

SYMBOL TUBES	TUBE SOCKET TERMINAL NUMBERS								
	1	2	3	4	5	6	7	8	9a
V1	350K+	100K	2700	12+	0	350K+	10M	0	8+
V2	350K+	450K	1500	12+	0	350K+	2.2M	30K	8+
V3	350K+	350K+	56K	12+	12+	350K+	340K	330	12+
V4	350K+	100Kb	2700	12+	0	350K+	10M	0	8+
V5	350K+	450K	1500	12+	12+	350K+	2.2M	30K	12+
V6	350K+	340K	330	12+	12+	350K+	350K+	56K	12+
V7	135	X	350K+	L	0	X	135	X	X
SUPPLY CAPACITORS	TERMINAL SYMBOLS	RESISTANCE		CHART NOTES K Kiloohm L Less than 1 ohm M Megohm X No connection + Minimum reading, rising as electrolytic capacitors charge. a Dual-filament junction, V1-V6 b 9K reading with equalization selector in EUR or LP position. c Sections of C9 (See parts list)					
C9	▲	350K+							
C18c	■	350K+							
C32c	—	350K+							
C42c	◐	350K+							
C49-A	◑	350K+							
C49-B	■	350K+							
C49-C	▲	350K+							
C50-A	▲	21+							
C50-B	◑	12+							

TUBE LAYOUT

MASTER AUDIO CONTROL-4000C

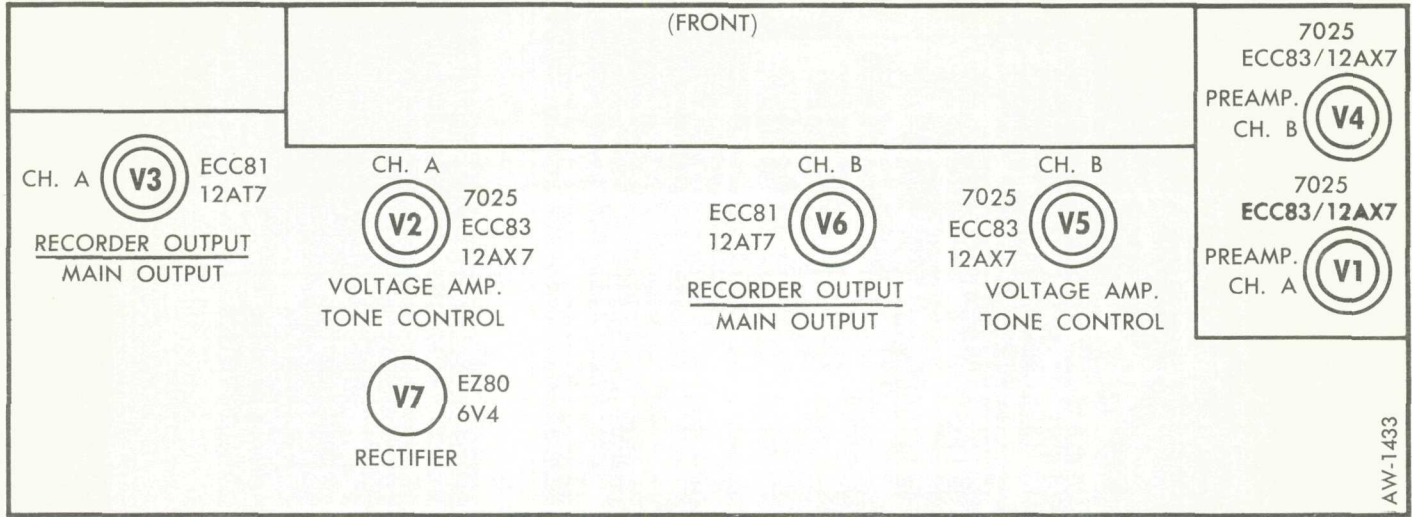

COMPONENT HOOK-UP CHART

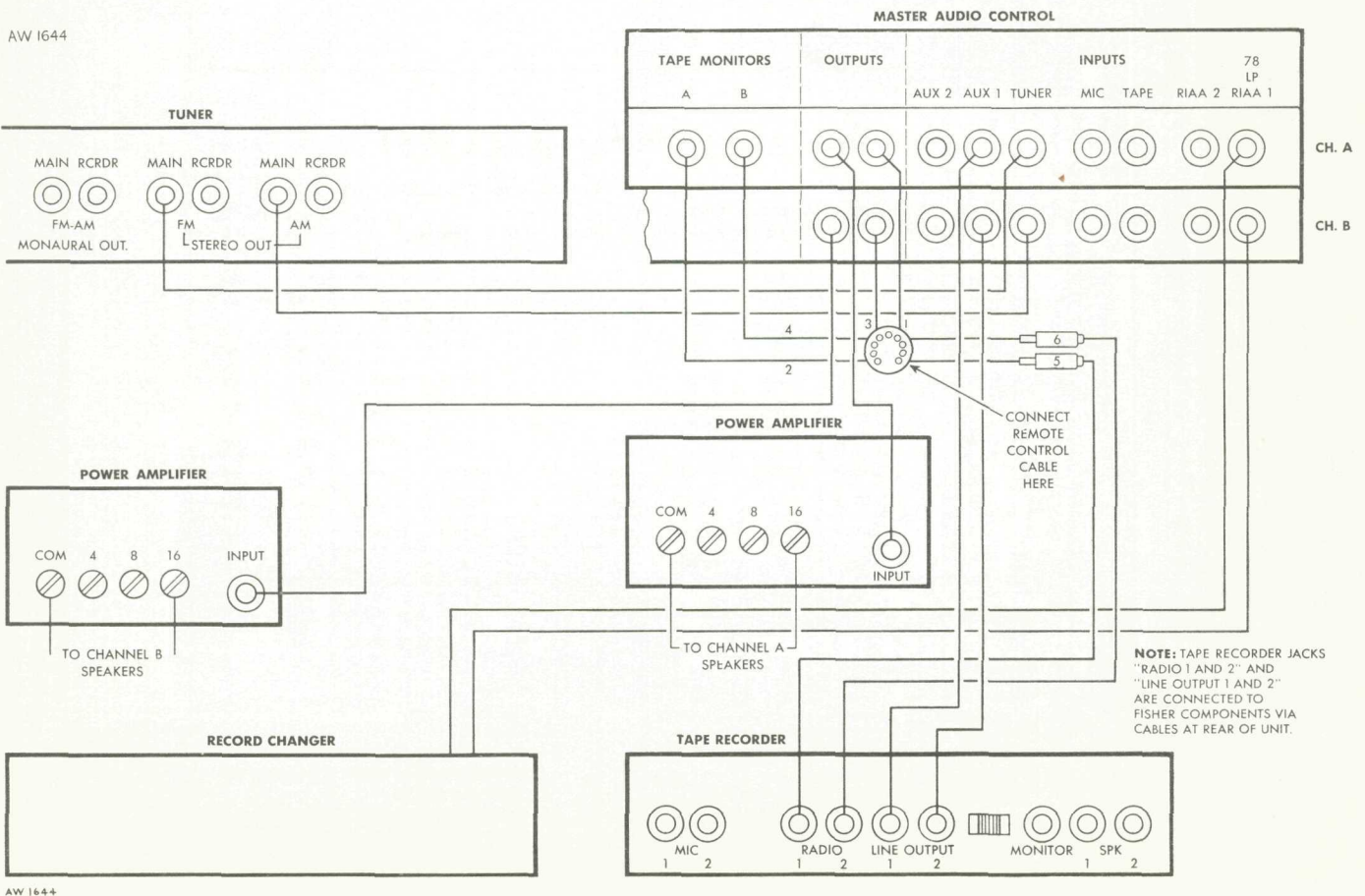

SCHEMATIC DIAGRAM • AMPLIFIER 100

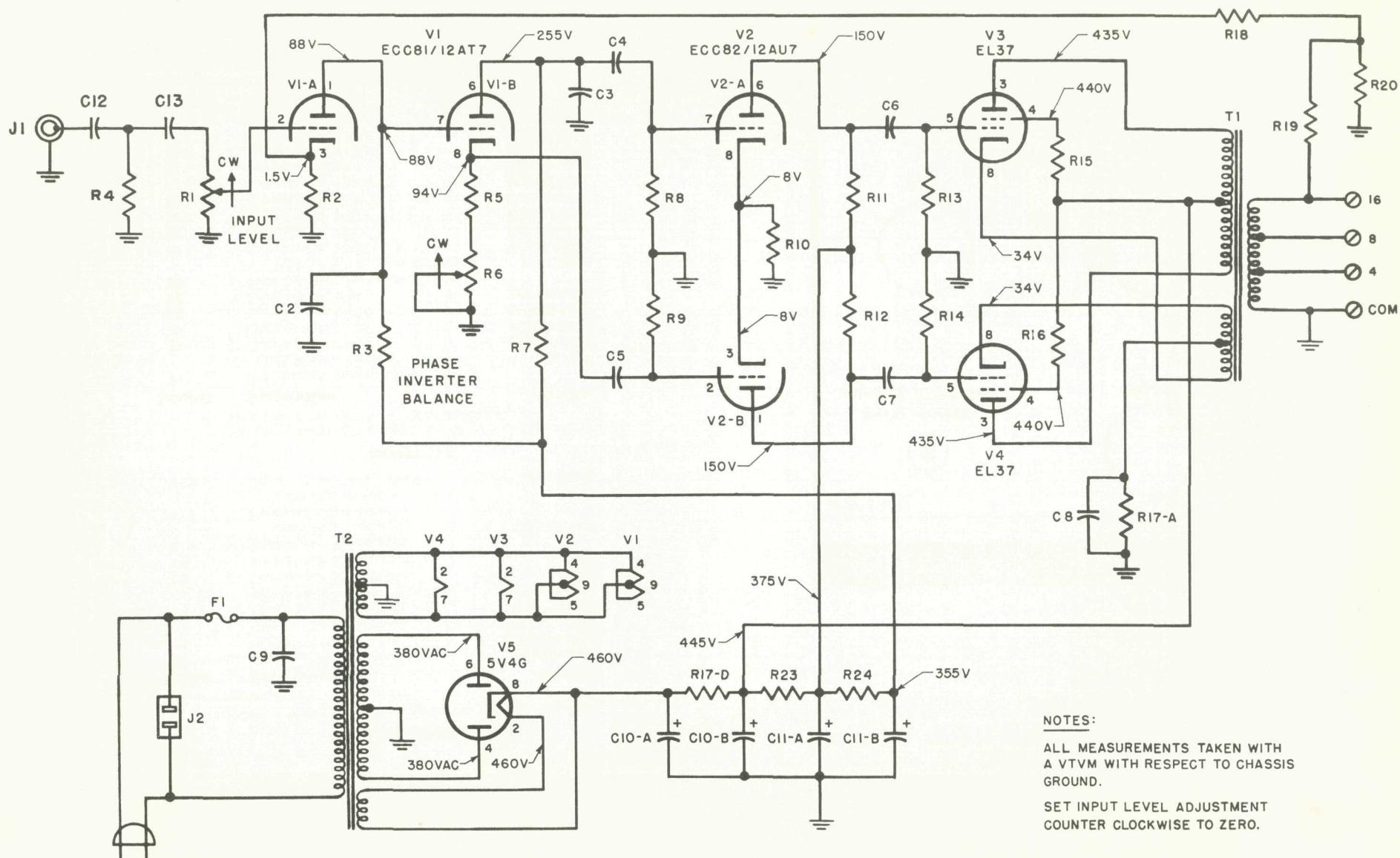

NOTES:
 ALL MEASUREMENTS TAKEN WITH
 A VTVM WITH RESPECT TO CHASSIS
 GROUND.
 SET INPUT LEVEL ADJUSTMENT
 COUNTER CLOCKWISE TO ZERO.

125-125 VOLTS AC
 50-60 CYCLES

AW 1416 SCHEMATIC P649

PARTS DESCRIPTION LIST AMPLIFIER 100

CAPACITORS

20% tolerance for all capacitors, unless otherwise noted.

Symbol	Description	Part No.
C1	Mylar .022uf, 10%, 250V	C50197-49
C2	Ceramic, 300uf, 10%, 500V	CC21GP301K5
C3	Ceramic, 120uf, 10%, 500V	CC21GP121K5
C4, 5	Molded tubular, .022uf, 400V	C68P223M4
C6, 7	Molded tubular, .047uf, 400V	C68P473M4
C8	Electrolytic, 50uf, 50V	C-508-115
C9	Molded tubular, .01uf, 600V	C-2747
C10	Electrolytic, two-section, each 40uf, 500V	C-522-114
C11	Electrolytic, two-section, each 40uf, 450V	C-1798
C12	Mylar, .01uf, 10%, 250V	C50197-48

RESISTORS

Values in ohms, 10% tolerance, 1/2 watt, unless otherwise noted. K=Kilohms. M=Megohms.

Symbol	Description	Part No.
R1	Potentiometer, composition, 500K, 1/4 W, input level	R-2815-9
R2	Composition, 1500	RC20BF152K
R3	Composition, 220K	RC20BF224K
R4	Composition, 470K	RC20BF474K
R5	Composition, 82K	RC20BF823K
R6	Potentiometer, composition, 50K, 1/4 W, phase inverter balance	R-50000-5
R7	Composition, 100K	RC20BF104K
R8, 9	Composition, 470K	RC20BF474K
R10	Composition, 2700	RC20BF272K
R11, 12	Composition, 150K	RC20BF154K
R13, 14	Composition, 470K	RC20BF474K
R15, 16	Composition, 68	RC20BF680K
R18	Composition, 4700	RC20BF472K
R19	Composition, 2200	RC20BF222K
R20	Composition, 330	RC20BF331K
R23, 24	Composition, 10K, 1W	RC30BF103K

TRANSFORMERS

Symbol	Description	Part No.
T1	Transformer, output	T-557-145
T2	Transformer, power	T-649-114

MISCELLANEOUS

Symbol	Description	Part No.
F1	Fuse, 3 ampere	F-3000
J1	Jack, input	J-3143
J2	Receptacle, auxiliary AC	J-546-129

TUBE LAYOUT AMPLIFIER 100

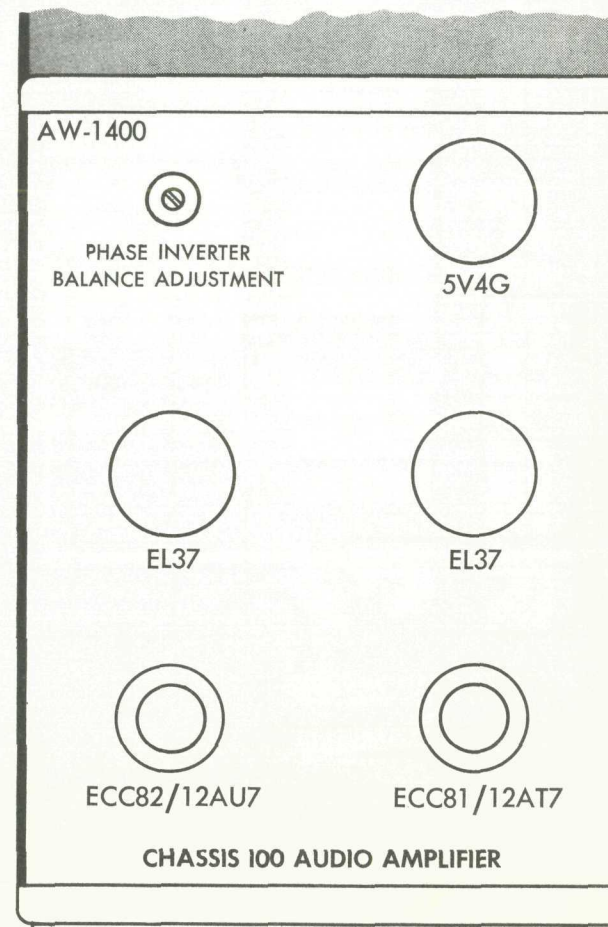

SCHEMATIC DIAGRAM • SPEAKER SYSTEMS

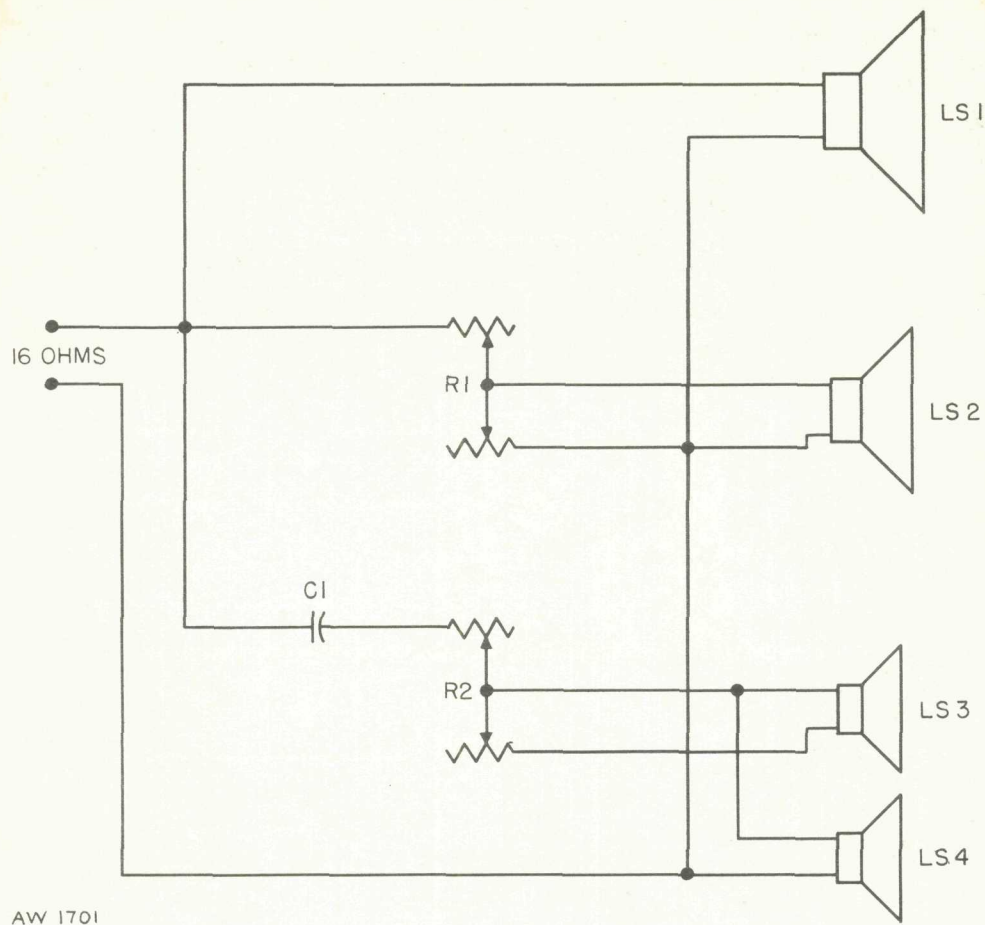

AW 1701

PARTS DESCRIPTION LIST • SPEAKER SYSTEMS

Symbol	Description	Part No.
C1	Capacitor, Electrolytic, Non-Polarized, 8uf, 20%, 50V	C687-120
LS1	Speaker, Woofer, 15-Inch 16 Ohms	LS687-119
LS2	Speaker, Mid-Range, 8-Inch, 16 Ohms	LS547-123
LS3, 4	Speaker, Tweeter, 16 Ohms	LS547-124
R1, R2	L-Pad, 15 Ohms	M211



FISHER RADIO CORPORATION • NEW YORK



N687-124

Printed in U.S.A.

508W150-129